

智能无线升降座管

使用说明书

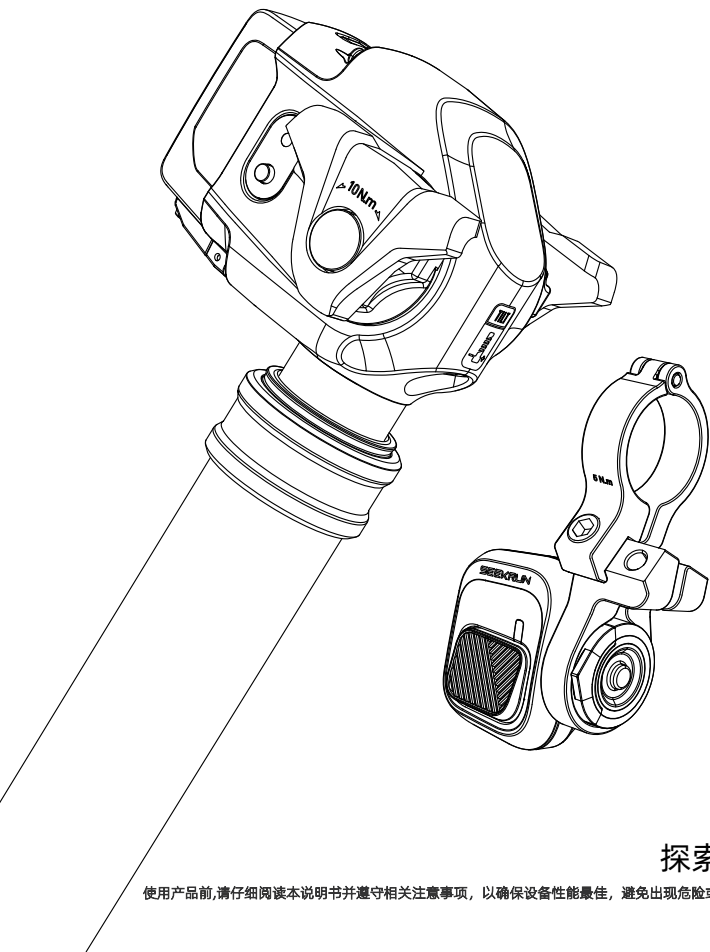

探索行动

使用产品前,请仔细阅读本说明书并遵守相关注意事项,以确保设备性能最佳,避免出现危险或非法情况。

⚠ WARNING

- **INGESTION HAZARD:** This product contains a button cell or coin battery.
- **DEATH** or serious injury can occur if ingested.
- A swallowed button cell or coin battery can cause **Internal Chemical Burns** in as little as **2 hours**.
- **KEEP** new and used batteries **OUT OF REACH** of **CHILDREN**
- **Seek immediate medical attention** if a battery is suspected to be swallowed or inserted inside any part of the body.



⚠ 警告和安全信息

1. SEEKRUN 产品应由专业自行车维修技师遵照SEEKRUN安装规范安装。SEEKRUN产品安装不当可引发故障，引起自行车失控，导致人员严重受伤甚至死亡。
2. 改动或改装 SEEKRUN 产品可能使其出现故障，进而导致人员严重受伤甚至死亡。请勿改动或改装 SEEKRUN 产品的任何零件。
3. 不当维修或在 SEEKRUN 产品上安装非 SEEKRUN 更换件可能导致产品出现故障，造成人员严重伤害甚至死亡。切勿使用大功率清洗器清洁SEEKRUN产品。本产品随附的指拨包含一块纽扣电池。唯一兼容的电池类型是CR2032(电池标称电压为 3V)。
4. 请把新电池和用过的电池放在儿童接触不到的地方。请勿吞咽电池，因为电池存在化学灼伤风险。如果不慎吞咽纽扣电池，可能会在短短两小时内造成严重体内灼伤，并且可能会导致严重人身伤害甚至死亡。如果您认为电池已吞咽或放入身体任何部位内，请立即就医。请致电当地的中毒控制中心，以了解相关的治疗信息。如果电池盒未安全闭合，请停止使用本产品，并把本产品放在儿童接触不到的地方。否则可能会导致严重人身伤害甚至死亡。
5. 请遵照当地法规移除和立即回收或处置废旧电池，并把废旧电池放在儿童接触不到的地方。电池不得与生活垃圾一起处置，亦不得焚烧电池。即便是废旧电池也可能造成严重伤害甚至死亡。非充电电池不可充电。请勿强制放电、充电、拆解、加热(高于制造商所规定的额定温度)或焚烧。否则可能会由于泄气、泄漏或爆炸导致化学灼伤，从而导致人身伤害。
6. 确保电池在安装后正负两极(+和-)正确朝向。请勿混合新旧电池，也请勿混合不同品牌或类型的电池(例如碱性电池、碳锌电池或可充电电池)。依照当地法规，从设备上移除并立即回收或处置长期未用的电池。请始终完全固定电池盒。如果电池盒未安全闭合，请停止使用本产品，并取下电池，把电池放在儿童接触不到的地方。
7. 确保 SEEKRUN 指拨不干扰刹车和变速杆的正常操作。如产生干扰，则会引起自行车失控，导致人员严重受伤甚至死亡
8. 在骑行期间使用SEEKRUN座管之前，请在安全、受控的环境中使用，以便充分了解座管的功能。鞍座的突然意外的撞击可能会导致你失去对自行车的控制，导致严重伤害或死亡。
9. 当您改变车座高度位置时，请按压指拨按键。在您降低车座高度时，用您的身体向下按压车座;当车座调回较高高度时，用您的身体引导车座。当座管达到您所需的位置时，请释放指拨按键。请始终在释放身体对车座的压力前首先释放指拨按键。将 SEEKRUN 座管用于技术要求较高的骑行场合前，请在您的能力范围内进行练习以获得使用 SEEKRUN 座管的专业技能。
10. 重要提示：未经制造商批准的更改或修改，可能导致用户操作设备的权限失效。
11. 本设备符合FCC规则第15部分。操作需满足以下两个条件：(1) 此设备不得造成有害干扰；(2) 此设备必须接受任何接收到的干扰，包括可能导致非预期操作的干扰。
12. 包含发射器模块 FCC ID: 2ABN2 - BG22A3

警告

1. 务必参阅您的自行车用户手册。SEEKRUN 产品应由专业自行车维修技师遵照 SEEKRUN 安装规范进行安装。SEEKRUN 产品安装不当可引发故障，引起自行车失控，导致人员严重受伤甚至死亡。
2. 以正确的朝向(对于碳纤维车架，请酌情使用止滑剂)。把座管插入车架中，超过您座管上的最低插入深度标记线。
3. SEEKRUN 座管具有方向性。正确朝向时，电池朝后方，使用指拨检查座管是否可以正常移动至所有位置。
4. 把座管设为所需的高度，然后把座管箍紧固螺栓拧紧至 44 in-lb (5 N·m) (如图所示)。插入后，确保座管上的“最低插入深度线”超过座管箍紧固螺栓(如图所示)。再次检查座管是否可以正常移动至所有位置。

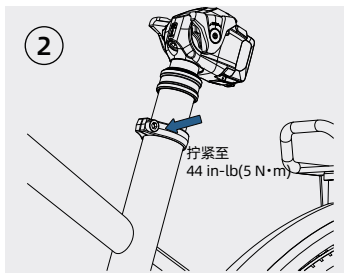
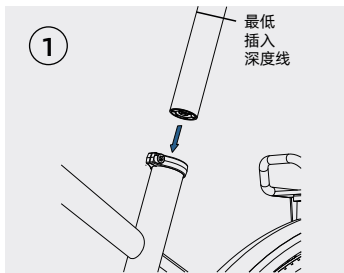

5. SEEKRUN 座管箍紧固螺栓的最大扭矩值为 44 in-lb (5 N·m)。实际所需扭矩将取决于骑行者重量、自行车架以及座管箍类型/品牌。正确的扭矩将支撑骑行者，并且不会干扰座管的功能。如果扭矩太大，则座管可能无法从任何位置完全回弹，或者可能无法正常地上下移动。如果扭矩太小座管可能无法支撑骑行者重量，或者可能无法在座管上保持静止状态。如果座管箍连接处的扭矩不当，则会引起自行车失控，导致人员严重受伤甚至死亡。
6. 不管自行车车架管自身配置如何，如需获得最佳结构性支撑效果，您应将 SEEKRUN 座管至少插入到①座管上的最低插标记位置，及自行车车架厂商规定的最低插入点。如忽视这两点，则存在车架和座管受损并导致人员严重受伤甚至死亡的风险。

注：本说明书中的图片均为示意图，可能与实物存在一定偏差，请以实物为准。

产品介绍

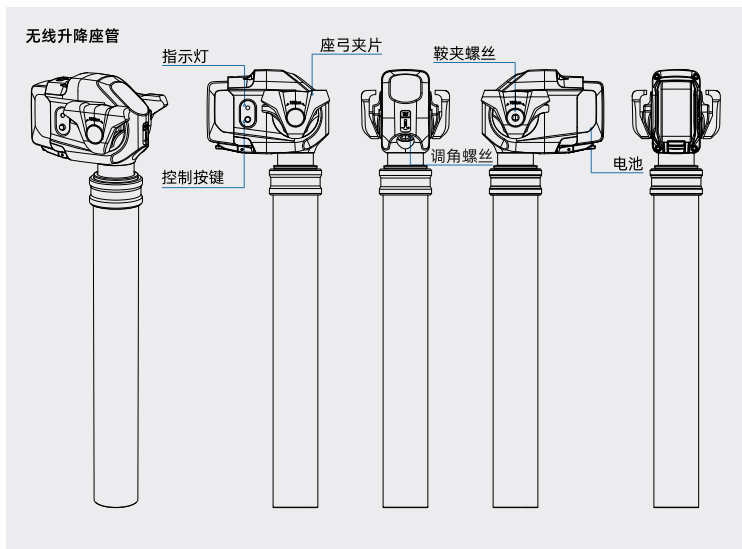

注：本说明书中的图片均为示意图，可能与实物存在一定偏差，请以实物为准。

部件清单

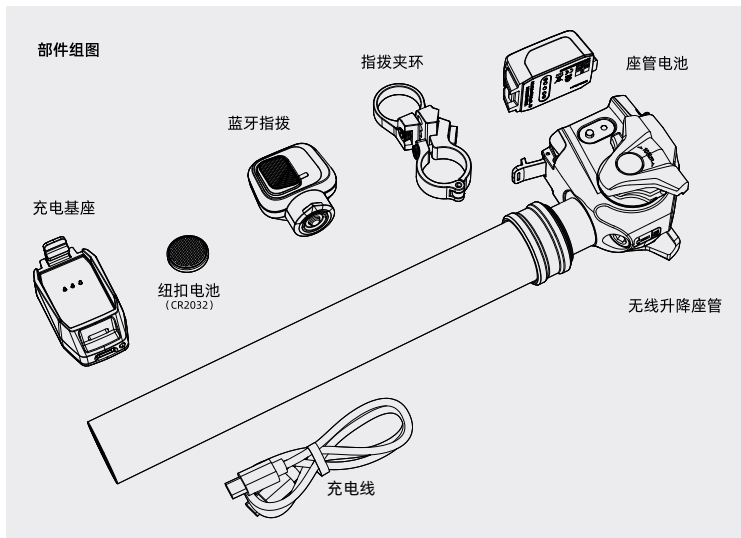

座管 & 蓝牙指拨电池安装

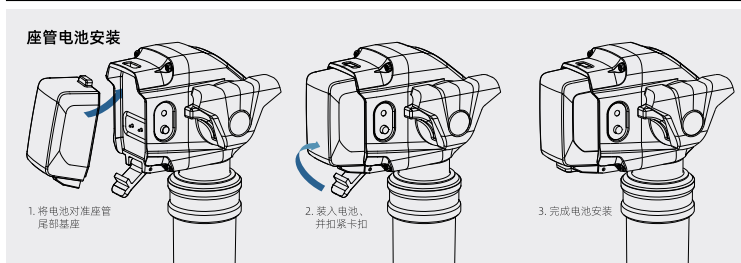

注：本说明书中的图片均为示意图，可能与实物存在一定偏差，请以实物为准。





提示：指拨使用的是型号为CR2032的纽扣电池；指拨由一个已安装的CR2032纽扣电池供电，一般带有字符“+”的一面为电池正极。

功能介绍

1. 蓝牙配对：长按指拨蓝牙配对键6秒，座管自动进入蓝牙配对模式；待指拨指示灯绿色常亮2秒再熄灭，即配对成功。(出厂已配对，更换电池不需要重新配对)
2. 指拨无操作一小时后自动进入关机状态，短按指拨按键即可开机正常使用；
3. 座管无操作一小时后自动进入休眠状态，一周后自动进入关机状态；
4. 座管休眠解除：长按指拨按键约3秒，或者短按指拨按键约3秒后再操控指拨按键，听到座管阀门开启声音，表明指拨和座管被唤醒，即可正常使用；
5. 座管关机解除：先短按一次座管上面的控制按键唤醒座管，再短按1秒指拨控制按键唤醒指拨，即可正常使用。

按键功能：

指拨 蓝牙配对键		长按6秒	蓝牙配对模式 / 恢复出厂设置
指拨 控制按键		按住	打开行程调节
		松开	关闭行程调节 / 锁定座管
座管 控制按键		短按	打开 / 关闭行程调节

注：本说明书中的图片均为示意图，可能与实物存在一定偏差，请以实物为准。

指拨 指示灯说明：



电池电量 > 10%

短按 指拨控制按键

绿灯闪烁1次 

电池电量 ≤ 10%

短按 指拨控制按键

红灯闪烁1次 

提示：为确保设备最佳性能，建议电量低于10%（指示灯红色闪烁）时，即可考虑尽早更换电池。

座管 指示灯说明：

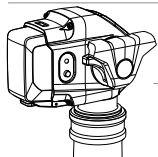

电池电量 > 20%

短按 座管控制按键

绿灯闪烁1次 

电池电量 ≤ 20%

短按 座管控制按键

红灯闪烁1次 

提示：为确保设备最佳性能，建议电量低于20%（指示灯红色闪烁）时，即可考虑尽早充电。

装车

- 1、建议用户安装后依据实际骑行体验再次调整座管高度，但注意座管的最小插入深度
- 2、座管夹的锁紧力请按照建议的锁紧力（ $\leq 5 \text{ N}\cdot\text{m}$ ）锁紧，若座管夹的锁紧力过大，易导致升降座管发生过量形变进而引发升降不流畅等问题，请勿过度锁紧。
- 3、长时间不使用座管时，请将座管升至最高，且拔出电池

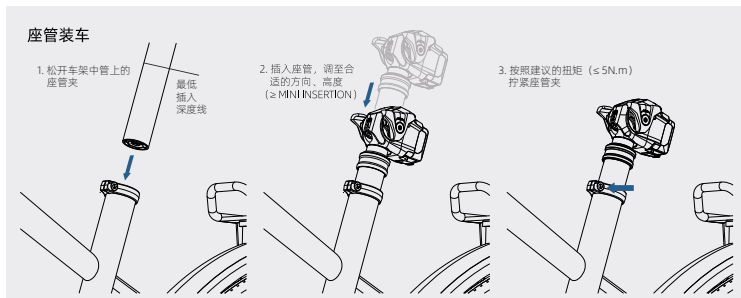

注：本说明书中的图片均为示意图，可能与实物存在一定偏差，请以实物为准。

鞍座固定

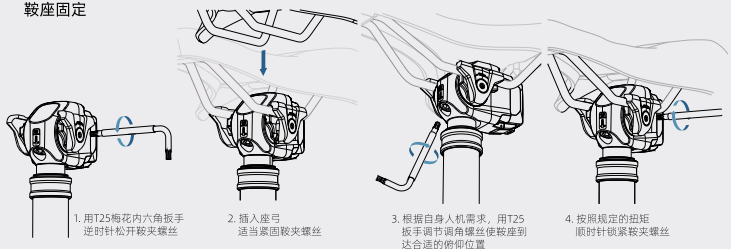

夹片可兼容座弓轨道规格：7MM圆形轨道/7x9MM椭圆形轨道；

提示：此处松紧调角螺丝、鞍夹螺丝均需T25梅花内六角扳手，具体细节按照上述流程操作即可。

指拨装车

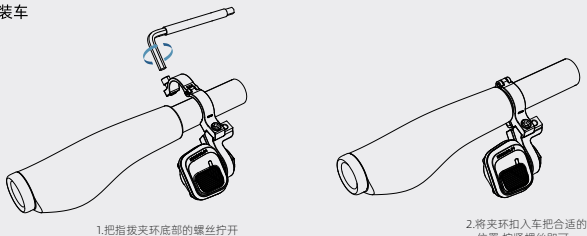

提示：初次安装可能存在安装位置不便于操作的情况，用户可在使用一段时间后，根据自己的习惯调整安装位置。

座管电池充电

当座管电量指示灯出现红灯闪烁情况时，表明座管电池电量过低，需要进行充电。

电源适配器最小输入规格为5V1A,建议选用额定输出功率为5V,额定输出电流不低于1A的电源适配器。

充电时环境温度应该保持在0°C-45°C，同时避免在潮湿环境中使用本品。

注：本说明书中的图片均为示意图，可能与实物存在一定偏差，请以实物为准。

座管电池充电

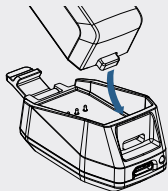

1. 将座管电池对准装配方向放入充电底座

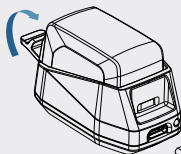

2. 扣紧卡扣、锁住电池

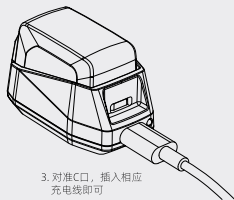

3. 对准C口，插入相应充电线即可

充电底座指示灯说明

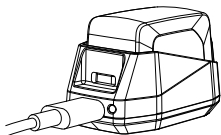

指示灯红绿交替快闪



底座通电

指示灯常亮红色



正在充电

指示灯常亮绿色



充电完成

指示灯红绿交替慢闪



充电故障

注意事项

1. 本产品防护等级为IP67。注意：该等级仅涉及鞍座头（电池正确安装的状态下）和指拨控制器，不包含管体。
2. 使用温度范围：放电状态-10℃至50℃；充电状态0℃至45℃；
3. 禁止将电池浸入水或其他液体中；
4. 座管电池充电接口需保持干燥。若有潮湿情况，请务必彻底擦干后再进行充电操作；
5. 禁止私自拆解、撞击、挤压座管电池，或将其投入火源及其他高温场所中；
6. 若电池出现明显膨胀、鼓包等异常现象，请立即停止使用；
7. 请勿将电池存放在高温处或发热设备的周围，如日照、微波炉、烤箱等；
8. 请勿将电池存放在婴幼儿可以触及的地方，避免因吞咬或误操作造成伤害；
9. 请勿将金属物导体与电池两极对接，或接触电池的端点；
10. 请按当地规定处理电池，不可将电池作为生活垃圾处理。
11. 座管电池在长时间存储时应每三个月充电一次，请使用充电底座充电0.5h~1h，确保电池组保持40%~60%电量。

相关认证



注：本说明书中的图片均为示意图，可能与实物存在一定偏差，请以实物为准。

产品保修说明

一、保修内容及期限

适用地区：中国大陆、欧盟、美国

生效日期：自购买之日起

授权经销商对该产品提供以下有限质保：

部件	质保时间
座管S7	12个月
电池	12个月
充电底座	12个月
蓝牙指拨	12个月

此质保赋予您相对于Suzhou Seekrun Technology Co., LTD（以下简称“SEEKRUN”）的特定法律权利。您可能还享有其他权利，这些权利在各州、各省或各国可能不同。本质保不影响您的法定权利。如果此质保的内容与某些地方法律有不一致之处，则视为将此质保修改为与此等地方法律一致。在某些司法管辖区（如欧盟），法律保证期可能长于本质保所述期限，本质保将作为对此类法定权利的补充而非替代。如需充分了解您的权利，请参阅您所在国家、省或州的法律。

此质保适用于

此质保适用于SEEKRUN Smart Dropper系列产品

注：本说明书中的图片均为示意图，可能与实物存在一定偏差，请以实物为准。

三、有限质保的范围

部件	故障
座管	材料缺陷、断裂、变形 座管无法上下行程调节 电系统不工作 无法连接蓝牙 蓝牙连接但不工作
电池/充电底座	无法充电
蓝牙指拨	不工作

一般规定

此质保只对第一购买主有效且不可转让。根据此质保提出任何售后时，必须通过向您销售 SEEKRUN 产品的零售商或者授权维修点提出，且需提供原始购买凭证。所有 SEEKRUN 质保索赔都由 SEEKRUN 的授权维修点进行评估。若授权经销商同意了质保售后，则授权经销商可自行决定对产品进行维修、更换或退款（退款金额不超过原始购买价格）。

质保期限：SEEKRUN 为产品提供自购买之日起一（1）年的有限质保。

在地方法律允许的限度内，根据此质保提出的任何索赔必须在质保期内或在此等索赔事项出现之日起一（1）年内提出。

注：因运输过程中需使用包装箱保证产品运输安全，建议您自签收之日起至少保留包装箱30天。

保养周期	保养内容
每次骑行后	用湿布擦拭座管伸缩部份的灰尘泥沙
每年/每骑行500小时/10000次	更换润滑油脂
每两年/每骑行1000小时/20000次	建议将产品送至授权售后服务中心 全面拆解保养，更换所有易损件
提醒：对于那些进行速降（DH）、公园骑行或极限自由骑，或者在极度潮湿 / 泥泞或干燥 / 多尘的环境条件下骑行的骑手，建议骑手根据需要比上述建议更早期地进行维护。如果您听到、看到或感觉到任何异常，请立即停止骑行，并联系授权服务中心进行妥善维修。	

探索行动 探索无限



若有售后服务需求，
发送邮件至邮箱：sales@seekrun.com

苏州探索行动科技有限公司 出品
地址：江苏省苏州市相城区青龙港路 286 号 6 号楼
邮编：215552

www.seekrun.com

SMART DROPPER

Operation instruction

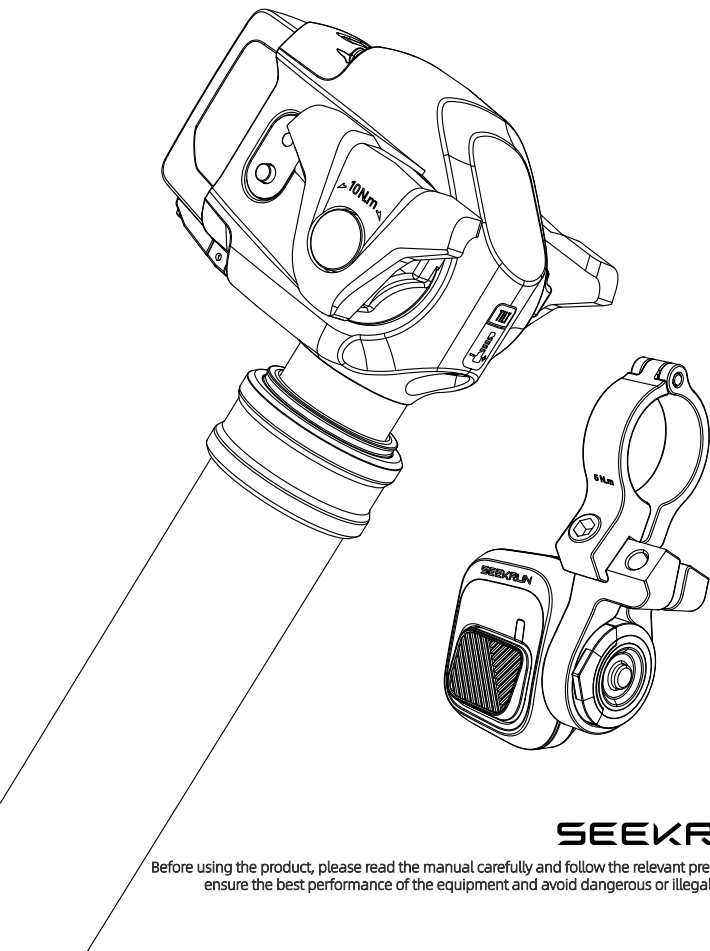

SEEKRUN

Before using the product, please read the manual carefully and follow the relevant precautions to ensure the best performance of the equipment and avoid dangerous or illegal situations.

⚠️ WARNING

- **INGESTION HAZARD:** This product contains a button cell or coin battery.
- **DEATH** or serious injury can occur if ingested.
- A swallowed button cell or coin battery can cause **Internal Chemical Burns** in as little as **2 hours**.
- **KEEP** new and used batteries **OUT OF REACH** of **CHILDREN**
- **Seek immediate medical attention** if a battery is suspected to be swallowed or inserted inside any part of the body.



⚠️ WARNINGS AND SAFETY INFORMATION

1. SEEKRUN products must be installed by professional bicycle maintenance technicians in accordance with the SEEKRUN installation specifications. Improper installation of SEEKRUN products may cause malfunctions, leading to bicycle loss of control, resulting in serious personal injury or even death.

2. Altering or modifying SEEKRUN products may cause them to malfunction, which in turn can lead to serious personal injury or even death. Do not alter or modify any parts of SEEKRUN products.

3. Improper maintenance or installation of non-SEEKRUN replacement parts on SEEKRUN products may cause product malfunctions, resulting in serious personal injury or even death. Do not clean SEEKRUN products with high-pressure washers. The remote included with this product contains a button battery. The only compatible battery type is CR2032 (nominal battery voltage: 3V).

4. Keep new and used batteries out of the reach of children. Do not swallow batteries as they pose a risk of chemical burns. Accidental swallowing of a button battery can cause severe internal burns in as little as two hours, which may lead to serious personal injury or even death. If you suspect a battery has been swallowed or inserted into any part of the body, seek medical attention immediately. Call your local poison control center for relevant treatment information. If the battery compartment is not securely closed, stop using the product and keep it out of the reach of children. Otherwise, it may result in serious personal injury or even death.

5. Follow local regulations to remove, promptly recycle or dispose of used batteries, and keep used batteries out of the reach of children. Batteries shall not be disposed of with household waste nor incinerated. Even used batteries may cause serious injury or even death. Non-rechargeable batteries must not be recharged. Do not force discharge, recharge, disassemble, heat (above the rated temperature specified by the manufacturer) or incinerate them. Otherwise, chemical burns may occur due to venting, leakage or explosion, leading to personal injury.

6. Ensure the positive (+) and negative (-) poles of the battery are correctly oriented after installation. Do not mix old and new batteries, nor mix batteries of different brands or types (e.g., alkaline, carbon-zinc, or rechargeable batteries). In accordance with local regulations, remove batteries from the device and promptly recycle or dispose of them if unused for a long period. Always secure the battery compartment fully. If the battery compartment is not closed securely, stop using the product, remove the battery, and keep the battery out of the reach of children.

7. Ensure the SEEKRUN remote does not interfere with the normal operation of brakes and gear levers. Any interference may cause loss of bicycle control, resulting in serious personal injury or even death.

8. Before using the SEEKRUN seatpost during riding, practice using it in a safe and controlled environment to fully understand its functions. Sudden and unexpected movement of the saddle may cause you to lose control of the bicycle, leading to serious injury or death.

9. Press the remote button when you want to adjust the saddle height. When lowering the saddle, press down on it with your body; when raising the saddle back to a higher position, guide it with your body. Release the remote button once the seatpost reaches your desired position. Always release the remote button first before removing body pressure from the saddle. Before using the SEEKRUN seatpost for technically demanding riding scenarios, practice within your ability to acquire professional skills in operating the SEEKRUN seatpost.

10. Important: Change or modifications not expressly approved by the manufacturer responsible for compliance could void the user's authority to operate the equipment.

11. This device complies with part 15 of the FCC Rules. Operation is subject to the following two conditions: (1) This device may not cause harmful interference, and (2) this device must accept any interference received, including interference that may cause undesired operation.

12. Contains FCC ID: 2ABN2-BG22A3

Warning

1. Be sure to refer to your bicycle's user manual. SEEKRUN products must be installed by professional bicycle repair technicians in accordance with the SEEKRUN installation specifications. Improper installation of SEEKRUN products may cause malfunctions, leading to loss of bicycle control, resulting in serious personal injury or even death.
2. Insert the seatpost into the seat tube in the correct orientation (for carbon fiber frames, use anti-slip compound as appropriate). Insert the seatpost into the frame beyond the minimum insertion depth mark on your seatpost.
3. The SEEKRUN seatpost is directional. When in the correct orientation, the battery faces rearward. Use the remote to check if the seatpost can move properly to all positions.
4. Set the seatpost to the desired height, then tighten the seatpost clamp bolt to 44 in-lb (5 N·m) (as shown in the figure). After insertion, ensure that the "minimum insertion depth mark" on the seatpost is beyond the seatpost clamp bolt (as shown in the figure). Check again that the seatpost can move properly to all positions.

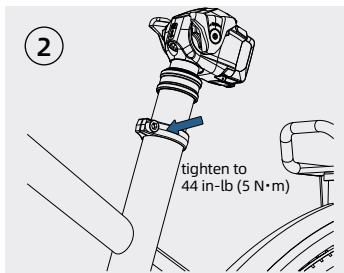
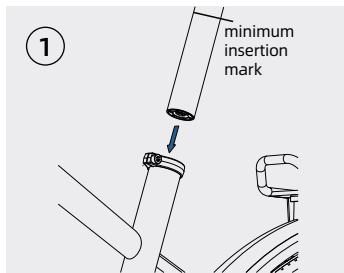

5. The maximum torque value for the SEEKRUN seatpost clamp bolt is 44 in-lb (5 N·m). The actual required torque will depend on the rider's weight, the bicycle frame, and the type/brand of the seatpost/seatpost clamp. Proper torque will support the rider without interfering with the seatpost's functionality. If the torque is too high, the seatpost may not fully rebound from any position or may fail to move up and down normally. If the torque is too low, the seatpost may not support the rider's weight or may not remain stationary in the seat tube. Improper torque at the seatpost/seatpost clamp connection may cause loss of bicycle control, resulting in serious personal injury or even death.
6. Regardless of the bicycle frame tube's own configuration, for optimal structural support, you must insert the SEEKRUN seatpost at least to ① the minimum insertion mark on the seatpost, and ② the minimum insertion point specified by the bicycle frame manufacturer. Failure to meet both requirements poses a risk of damage to the frame and seatpost, leading to serious personal injury or even death.

Note: All the pictures in this manual are schematic diagrams and may differ from the actual items to some extent. Please refer to the actual items.

PRODUCT INTRODUCTION

BLUETOOTH REMOTE

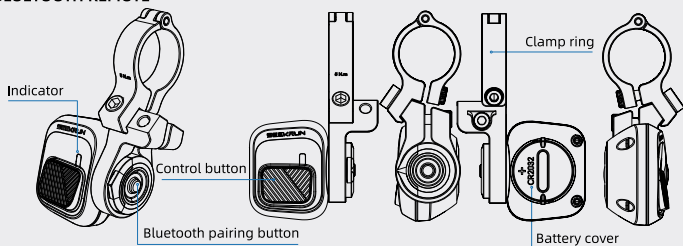

WIRELESS DROPPER SEATPOST

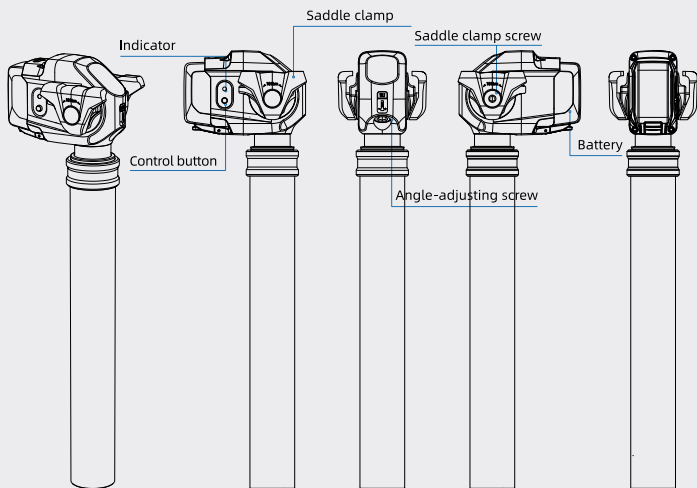

Note: All the pictures in this manual are schematic diagrams and may differ from the actual items to some extent. Please refer to the actual items.

COMPONENT LIST

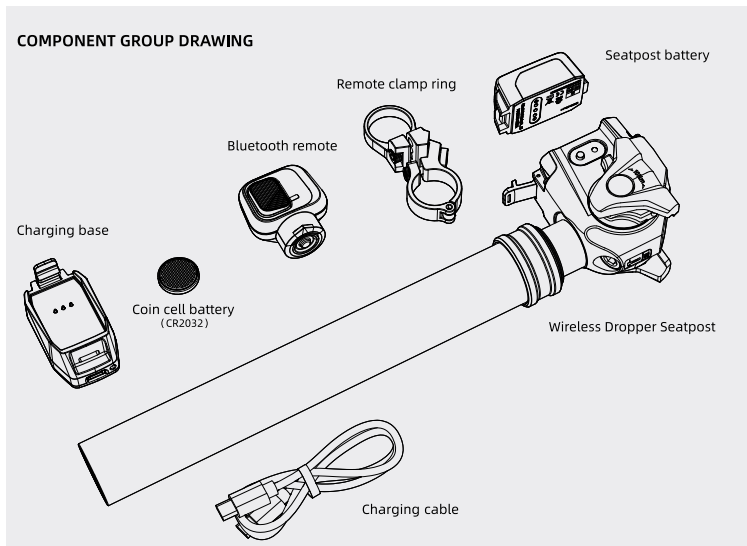

SEATPOST & BLUETOOTH REMOTE BATTERY INSTALLATION

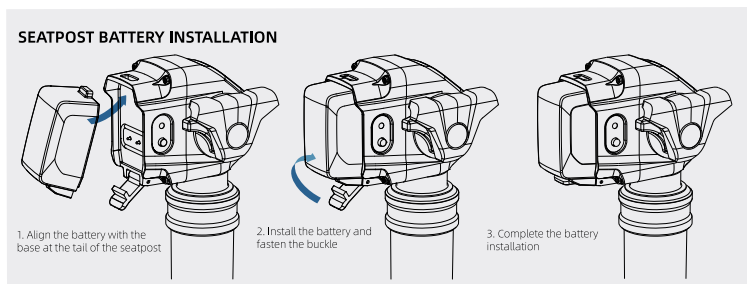

Note: All the pictures in this manual are schematic diagrams and may differ from the actual items to some extent. Please refer to the actual items.

REMOTE BATTERY INSTALLATION

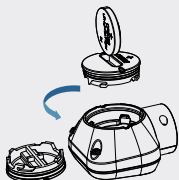

1. Use a CR2032 battery or other suitable tool to rotate the compartment cover counterclockwise to remove it;



2. Insert the CR2032 battery into the battery compartment with the positive terminal (marked "+") facing outward;

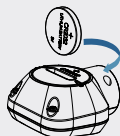

3. Use the appropriate tool to rotate the cover clockwise into the remote module

Note: The shifter uses a CR2032 button battery; it is powered by a pre-installed CR2032 button battery. Generally, the side marked with the "+" symbol is the positive pole of the battery.

FUNCTION INTRODUCTION

1. Bluetooth Pairing: Long press the Bluetooth pairing button on the remote for 6 seconds, and the seatpost will automatically enter Bluetooth pairing mode. The pairing is successful when the remote indicator light stays solid green for 2 seconds and then turns off. (The device comes pre-paired from the factory; re-pairing is not required after battery replacement.)

2. The remote will automatically turn off if left idle for 1 hour. Short press any button on the remote to power it on for normal use.

3. The seatpost will automatically enter sleep mode if left idle for 1 hour, and will shut down completely after 1 week of inactivity.

4. Wake the Seatpost from Sleep Mode: Either long press the remote button for approximately 3 seconds, or short press the remote button for around 3 seconds and then operate it again. You will hear the sound of the seatpost valve opening, indicating that both the remote and seatpost have been woken up and are ready for normal use.

5. Restore the Seatpost from Shutdown Mode: First, short press the control button on the seatpost once to wake the seatpost. Then, short press the control button on the remote for 1 second to wake the remote. The system can then be used normally.

BUTTON FUNCTION

Remote Bluetooth pairing button



Long press for 6 seconds

Bluetooth pairing mode/
Restore factory settings

Remote control button



Press and hold

Turn on the travel adjustment

Release

Turn off the travel adjustment/
lock seatpost

Seatpost control button





Short press

Turn on/off the travel adjustment

Note: All the pictures in this manual are schematic diagrams and may differ from the actual items to some extent. Please refer to the actual items.

REMOTE INDICATOR DESCRIPTION



Battery power > 10%	Short press remote control button	1 green blink 
Battery power ≤ 10%	Short press remote control button	1 red blink 

To ensure the best performance of the device, it is recommended that when the battery level drops below 10% (with the indicator light flashing red), you can consider replacing the battery as soon as possible.

SEATPOST INDICATOR DESCRIPTION

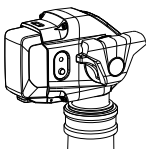

Battery power > 20%	Short press seatpost control button	1 green blink 
Battery power ≤ 20%	Short press seatpost control button	1 red blink 

Note: To ensure the best performance of the device, it is recommended that you consider charging it as soon as the battery level drops below 20% (with the indicator flashing red).

INSTALLATION

1. After installation, it is recommended to adjust the seatpost height again according to your actual riding experience. Note the minimum insertion depth of the seatpost (do not insert it shallower than the safety mark).
2. Tighten the seatpost clamp to the recommended torque (< 5 N·m). Excessive tightening torque may cause excessive deformation of the electric dropper post, leading to issues such as unsmooth lifting/lowering. Do not over-tighten.
3. When the seatpost is not in use for a long time, raise it to the highest position and remove the battery.

SEATPOST INSTALLATION

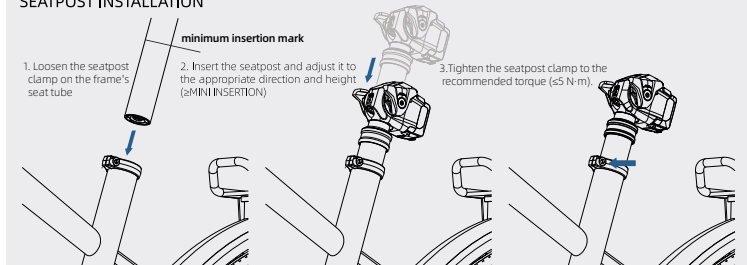

Note: All the pictures in this manual are schematic diagrams and may differ from the actual items to some extent. Please refer to the actual items.

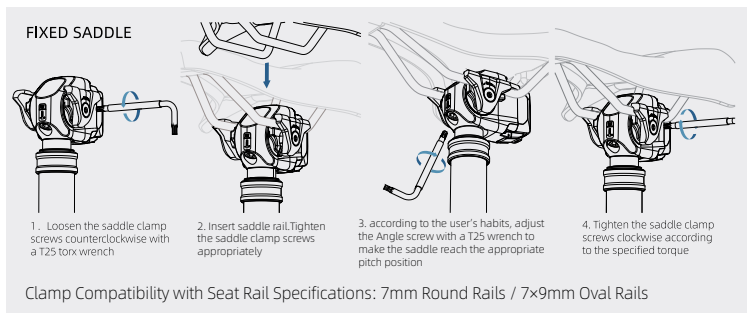

Note: A T25 Torx Allen wrench is required for both the angle adjustment screw and the saddle clamp screw where. Follow the above procedures for specific details.

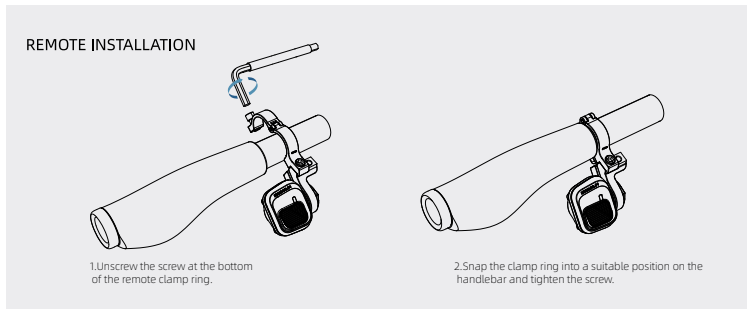

Note: Inconvenient operating positions may occur during initial installation. Users can adjust the mounting position according to their personal habits after a period of use

SEATPOST BATTERY CHARGING

When the red light of the seatpost battery indicator flashes, it indicates that the battery power of the seatpost is too low and it needs to be charged.

The minimum input specification of the power adapter is 5V 1A. It is recommended to use a power adapter with a rated output voltage of 5V and a rated output current of not less than 1A.

When charging, the ambient temperature should be maintained between 0°C and 45°C. At the same time, avoid using this product in a humid environment.

Note: All the pictures in this manual are schematic diagrams and may differ from the actual items to some extent. Please refer to the actual items.

SEATPOST BATTERY CHARGING

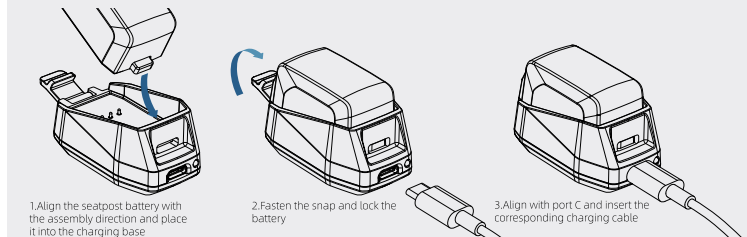

CHARGING BASE INDICATOR DESCRIPTION

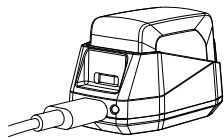

The indicator light flashes red and green alternately in a rapid pattern



Power on the base

The indicator is constantly on red



Charging now

The indicator is constantly on green



Charging completed

The indicator light flashes red and green alternately at a slow pace



charging fault

PRECAUTIONS

1. This product has an IP67 protection rating. Note: This rating applies only to the saddle head (with the battery properly installed) and the remote control lever, and does not cover the tube .
2. Temperature range for use: discharged state (up and down) -10 °C to 50 °C; charging state 0 °C to 45 °C;
3. Do not immerse the battery in water or other liquids;
4. The charging interface of the seatpost battery needs to be kept dry. If there is moisture, please wipe thoroughly before charging;
5. It is prohibited to dismantle, impact, squeeze the seatpost battery without authorization, or put it into a fire source or other high-temperature places;
6. If the battery shows obvious swelling, bulges or other abnormal phenomena, please stop using it immediately;
7. Do not store batteries in high temperature areas or around heating devices such as sunlight, microwave ovens, ovens, etc;
8. Do not store the battery in a place where infants and young children can reach it, to avoid injury caused by ingestion or misoperation;
9. Do not connect metal conductors to the two poles of the battery or touch the endpoints of the battery;
10. Please dispose of batteries according to local regulations and do not dispose of them as household waste.
11. For long-term storage of the seatpost battery, recharge it every three months. Use the dedicated charging base and charge for 0.5-1 hour to ensure the battery pack maintains a charge level of 40%-60%.

RELEVANT CERTIFICATIONS



Note: All the pictures in this manual are schematic diagrams and may differ from the actual items to some extent. Please refer to the actual items.

PRODUCT WARRANTY INSTRUCTIONS

1、WARRANTY CONTENT AND PERIOD

Applicable regions: Chinese mainland, the European Union, the United States

Effective date: From the date of purchase

Authorized Dealer offers the following limited warranties for this product:

Component	Warranty period
Seatpost S7	12 months
Battery	12 months
Charging base	12 months
Bluetooth remote	12 months

Tip: This warranty is only valid for the first buyer and is non transferable.

When making any claim under this warranty, it must be made through the retailer or authorized repair point that sells SEEKRUN products to you, and the original purchase voucher must be provided.

All SEEKRUN warranty claims are evaluated by authorized repair points of SEEKRUN. If Authorized Dealer agrees to the warranty claim, Authorized Dealer may decide on its own to repair, replace or refund the product. Within the limits permitted by local laws, any claim made under this warranty must be made within the warranty

2、NON-WARRANTY REGULATIONS

1. Unauthorized repair, misuse, collision, negligence, abuse, liquid ingress, accident, modification, incorrect use of non product accessories, or tearing, altering labels, anti-counterfeiting marks;
2. The validity period of the three guarantees has passed;
3. Damage caused by force majeure;
4. Failure to comply with the performance faults listed in the "Product Fault Table";
5. Due to human factors, this product and its accessories may experience performance failures as listed in the "Product Failure Table".

Note: All the pictures in this manual are schematic diagrams and may differ from the actual items to some extent. Please refer to the actual items.

3. Scope of Limited Warranty

Component	Fault
Seatpost	Material defects, fractures, deformations The seatpost cannot be adjusted for up and down travel The electrical system is not working Unable to connect to Bluetooth The Bluetooth connection is not working
Battery/charging base	Cannot charge
Bluetooth remote	Not working

Note: As the packaging box is required during transportation to ensure the safety of the product, it is recommended that you keep the packaging box for at least 30 days from the date of signature for receipt.

Maintenance Interval	Maintenance Content
After each ride	Wipe dust and sand from the telescopic part of the seatpost with a damp cloth.
Annually / Every 500 riding hours / 10,000 cycles	Replace lubricating grease.
Every two years / Every 1,000 riding hours / 20,000 cycles	It is recommended to send the product to an authorized after-sales service center for full disassembly, maintenance, and replacement of all wear parts.
<p>Reminder: For riders engaging in downhill (DH), park riding, or extreme freeride, or riding in extremely wet/muddy or dry/dusty environmental conditions it is recommended to perform maintenance earlier than the above suggestions as needed. If you hear, see, or feel any abnormality, stop riding immediately and contact an authorized service center for proper repair.</p>	

SEEKRUN SEEKMORE



If after-sales service is required,
or send an email to: sales@seekrun.com

Produced by Suzhou Seekrun Technology Co., Ltd.

ADD: Building 6, No. 286, Qinglonggang Road
Xiangcheng District, Suzhou, Jiangsu, China
Postal Code: 215552

www.seekrun.com